

Control Switch

K25F AL guard type



Pilot Light



Non-Illuminated Push Button Switch



Illuminated Push Button Switch

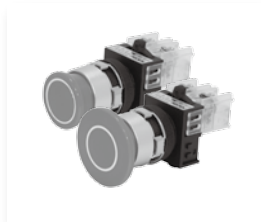

Non-Illuminated Mushroom Push Button Switch



Illuminated Mushroom Push Button Switch



Non-Illuminated Selector Switch



Illuminated Selector Switch



Illuminated Buzzer

Part Number Description

K - **1** - **2** **3** **4** - **5** AL **6**

1 Operator Type	25F : Ø25		
2 Bezel Type	1 : Pilot Light 4 : 2 Step Selector	2 : Momentary 5 : 3 Step Selector	3 : Maintained BZ : Buzzer
3 Illumination & Shape	1 : Non-Illumination Round	4 : Illumination Round	7 : Illumination Round(LED)
4 Color	R : Red B : Blue	G : Green K : Black	Y : Yellow W : White
5 Second Standard	N29 : Ø29 S2R : 2 Step Auto Short Lever S3R : 3 Step Right Auto Short Lever L2R : 2 Step Auto Long Lever L3R : 3 Step Right Auto Long Lever	N40 : Ø40 S3LR : 3 Step Both Auto Short Lever L3LR : 3 Step Both Auto Long Lever L : Long Lever (Non illuminated type only)	S3L : 3 Step Left Auto Short Lever L3L : 3 Step Left Auto Long Lever
6 Rated Voltage	None : No Voltage 110VAC	24VDC 220VAC	110VDC

Specification

Contact Ratings	Material	Ag alloy			
	Rated Current	voltage	AC 1	AC 3	DC 1
		24V	10A	10A	6A
		48V	10A	10A	3A
		110V	10A	6A	2A
		250V	6A	4A	1A
		440V	2A	1.5A	-
	Life Cycles	Mechanical	Min. 200,000		
		Electrical	Min. 2,000,000 (Emergency, Selector : Min. 500,000)		
	Minimum Switching Current		10A		
Minimum Switching Voltage		440VAC			
Contact Resistance		50mΩ			
Illumination	Normal Current	AC	Filament	160mA	
			LED	15mA	
		DC	Filament	50mA	
			LED	15mA	
	Life Cycles	Filament	Min. 1,000hrs		
		LED	Min. 50,000hrs		
General Ratings	Dielectric Strength		1,800VAC for 1 minute		
	Degree of Protection		IP40		
	Insulation Resistance		100MΩ (500VDC) for 1 minute		
	Frequency of Alteration		30 / 1 Minute		
	Ambient Temperature		-25°C - + 70°C (with no icing)		
	Torque		0.8N·m (8.16kgf·m)		

☞ Specifications and materials can be changed without prior notice for the enhancement of the quality.

Control Switch

K25F AL series - Non-flush type

Product Selection

Operator Type	Panel Cutting Hole	Contact Form	Color	Part Number	Rated Voltage
Illuminated LED Pilot Light 	Ø25	-	Red	K25F-17R-AL	12/24VDC 110VDC 110/220VAC
			Green	K25F-17G-AL	
			Yellow	K25F-17Y-AL	
			Blue	K25F-17B-AL	
			White	K25F-17W-AL	
			Black	K25F-17K-AL	
Momentary Non-Illuminated Push Button Switch 	Ø25	1N/O	Red	K25F-21R-AL	-
			Green	K25F-21G-AL	
			Yellow	K25F-21Y-AL	
			Blue	K25F-21B-AL	
			White	K25F-21W-AL	
			Black	K25F-21K-AL	
Maintained Non-Illuminated Push Button Switch 	Ø25	1N/O	Red	K25F-31R-AL	-
			Green	K25F-31G-AL	
			Yellow	K25F-31Y-AL	
			Blue	K25F-31B-AL	
			White	K25F-31W-AL	
			Black	K25F-31K-AL	
Momentary Illuminated LED Push Button Switch 	Ø25	1N/O	Red	K25F-27R-AL	12/24VDC 110VDC 110/220VAC
			Green	K25F-27G-AL	
			Yellow	K25F-27Y-AL	
			Blue	K25F-27B-AL	
			White	K25F-27W-AL	
			Black	K25F-27K-AL	
Maintained Non-Illuminated LED Push Button Switch 	Ø25	1N/O	Red	K25F-37R-AL	12/24VDC 110VDC 110/220VAC
			Green	K25F-37G-AL	
			Yellow	K25F-37Y-AL	
			Blue	K25F-37B-AL	
			White	K25F-37W-AL	
			Black	K25F-37K-AL	

Product Selection











Operator Type	Panel Cutting Hole	Head Type	Contact Form	Color	Selector Type	Operator Function	Part Number	Rated Voltage
Non-Illuminated Selector Switch (2 Position) 	Ø25	Knob Type	1N/O	Black	Maintained		K25F-41K-AL	-
				Red			K25F-41R-AL	
				Green			K25F-41G-AL	
				Yellow			K25F-41Y-AL	
				Blue			K25F-41B-AL	
				Black	Spring Return		K25F-41K-S2R AL	
				Red			K25F-41R-S2R AL	
				Green			K25F-41G-S2R AL	
				Yellow			K25F-41Y-S2R AL	
				Blue			K25F-41B-S2R AL	
Non-Illuminated Selector Switch (2 Position) 	Ø25	Lever Type	1N/O	Black	Maintained		K25F-41K-L AL	-
				Red			K25F-41R-L AL	
				Green			K25F-41G-L AL	
				Yellow			K25F-41Y-L AL	
				Blue			K25F-41B-L AL	
				Black	Spring Return		K25F-41K-L2R AL	
				Red			K25F-41R-L2R AL	
				Green			K25F-41G-L2R AL	
				Yellow			K25F-41Y-L2R AL	
				Blue			K25F-41B-L2R AL	
Illuminated LED Selector Switch (2 Position) 	Ø25	Knob Type	1N/O	Black	Maintained		K25F-47R-AL	12/24VDC 110VDC 110/220VAC
				Red			K25F-47G-AL	
				Green			K25F-47Y-AL	
				Yellow			K25F-47B-AL	
				Blue			K25F-47W-AL	
				Black	Spring Return		K25F-47R-S2R AL	
				Red			K25F-47G-S2R AL	
				Green			K25F-47Y-S2R AL	
				Yellow			K25F-47B-S2R AL	
				Blue			K25F-47W-S2R AL	

Human-Machine Interface

Control Switch

K25F AL series - Non-flush type

Product Selection

Operator Type	Panel Cutting Hole	Head Type	Contact Form	Color	Selector Type	Operator Function	Part Number	Rated Voltage
Non-Illuminated Selector Switch (3 Position) 	Ø25	Knob Type	2N/O	Black	Maintained		K25F-51K-AL	-
				Red			K25F-51R-AL	
				Green			K25F-51G-AL	
				Yellow			K25F-51Y-AL	
				Blue			K25F-51B-AL	
				Black	Left Auto		K25F-51K-S3L AL	-
				Red			K25F-51R-S3L AL	
				Green			K25F-51G-S3L AL	
				Yellow			K25F-51Y-S3L AL	
				Blue			K25F-51B-S3L AL	
				Black	Right Auto		K25F-51K-S3R AL	-
				Red			K25F-51R-S3R AL	
				Green			K25F-51G-S3R AL	
				Yellow			K25F-51Y-S3R AL	
				Blue			K25F-51B-S3R AL	
Black	Both Auto		K25F-51K-S3LR AL	-				
Red			K25F-51R-S3LR AL					
Green			K25F-51G-S3LR AL					
Yellow			K25F-51Y-S3LR AL					
Blue			K25F-51B-S3LR AL					
Non-Illuminated Selector Switch (3 Position) 		Lever Type	2N/O	Black	Maintained		K25F-51K-L AL	-
				Red			K25F-51R-L AL	
				Green			K25F-51G-L AL	
				Yellow			K25F-51Y-L AL	
				Blue			K25F-51B-L AL	
				Black	Left Auto		K25F-51K-L3L AL	-
				Red			K25F-51R-L3L AL	
				Green			K25F-51G-L3L AL	
				Yellow			K25F-51Y-L3L AL	
				Blue			K25F-51B-L3L AL	
				Black	Right Auto		K25F-51K-L3R AL	-
				Red			K25F-51R-L3R AL	
				Green			K25F-51G-L3R AL	
				Yellow			K25F-51Y-L3R AL	
				Blue			K25F-51B-L3R AL	
Black	Both Auto		K25F-51K-L3LR AL	-				
Red			K25F-51R-L3LR AL					
Green			K25F-51G-L3LR AL					
Yellow			K25F-51Y-L3LR AL					
Blue			K25F-51B-L3LR AL					

Product Selection





Operator Type	Panel Cutting Hole	Head Type	Contact Form	Color	Selector Type	Operator Function	Part Number	Rated Voltage	
Illuminated LED Selector Switch (3 Position)	Ø25		Red	Maintained			K25F-57R-AL	12/24VDC 110VDC 110/220VAC	
			Green				K25F-57G-AL		
			Yellow				K25F-57Y-AL		
			Blue				K25F-57B-AL		
			White				K25F-57W-AL		
			Red	Left Auto			K25F-57R-S3L AL		12/24VDC 110VDC 110/220VAC
			Green				K25F-57G-S3L AL		
			Yellow				K25F-57Y-S3L AL		
			Blue				K25F-57B-S3L AL		
			White				K25F-57W-S3L AL		
	Red	Right Auto			K25F-57R-S3R AL	12/24VDC 110VDC 110/220VAC			
	Green				K25F-57G-S3R AL				
	Yellow				K25F-57Y-S3R AL				
	Blue				K25F-57B-S3R AL				
	White				K25F-57W-S3R AL				
	Red	Both Auto			K25F-57R-S3LR AL	12/24VDC 110VDC 110/220VAC			
	Green				K25F-57G-S3LR AL				
	Yellow				K25F-57Y-S3LR AL				
	Blue				K25F-57B-S3LR AL				
	White				K25F-57W-S3LR AL				
		Knob Type	2N/O						











Control Switch

K25F AL series - Non-flush type

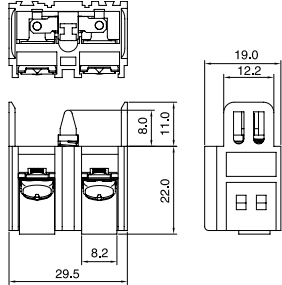
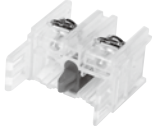
Product Selection

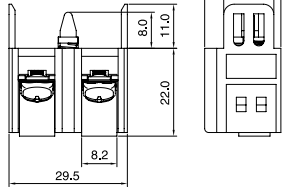
Operator Type	Shape	Contact Form	Color	Part Number	Rated Voltage
Ø29 Non-Illuminated Mushroom Push Button Switch 	Ø25	1N/C	Red	K25F-21R-N29 AL	-
			Green	K25F-21G-N29 AL	
			Yellow	K25F-21Y-N29 AL	
Ø40 Non-Illuminated Mushroom Push Button Switch 	Ø25	1N/C	Red	K25F-21R-N40 AL	-
			Green	K25F-21G-N40 AL	
			Yellow	K25F-21Y-N40 AL	
Ø29 Illuminated Mushroom Push Button Switch 	Ø25	1N/C	Red	K25F-27R-N29 AL	12/24VDC 110VDC 110/220VAC
			Green	K25F-27G-N29 AL	
			Yellow	K25F-27Y-N29 AL	
Ø40 Illuminated Mushroom Push Button Switch 	Ø25	1N/C	Red	K25F-27R-N40 AL	12/24VDC 110VDC 110/220VAC
			Green	K25F-27G-N40 AL	
			Yellow	K25F-27Y-N40 AL	
Illuminated Buzzer 	Ø25	-	-	K25F-BZ-AL	90VAC - 240VAC 12VDC - 24VDC

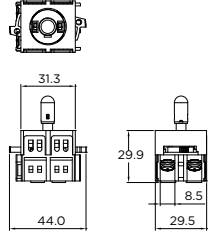
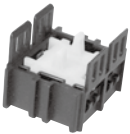
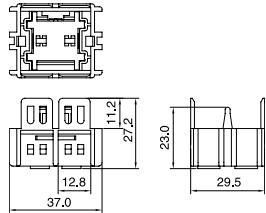
Accessory

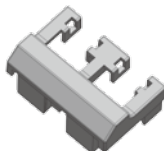

	Operator Type	Contact	Part Number	Rated Voltage	Dimension
	1NO Contact		CBA	-	
	1NC Contact	 AC15 DC13 ※ Positive opening type	CBB	-	
	LED Trans	X1—(X)—X2	KT- [Ⓐ]	12/24VDC 110VDC 110/220VAC	
[Ⓐ] - Color : Red / Green / Yellow / Blue / White					
	Maintain Holder		KAL	-	
	Contact block Safety Cover With hole		KP-10	-	
	Contact block Safety Cover		KP-11	-	

Human-Machine Interface

Control Switch

K25F AL series - Non-flush type

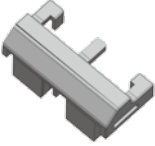
Option

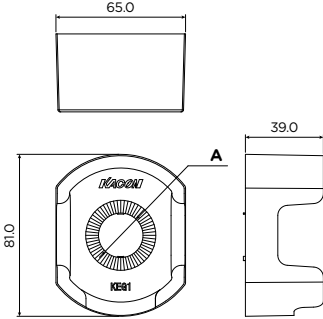
	Operator Type	Shape	Part Number	Dimension						
	Trans block Safety Cover With hole		KP-20	-						
	Trans Safety Cover		KP-21	-						
	Protection Cover	<p>Ø25</p> <p>Ø30</p>	<p>KEG15[Ⓐ]</p> <p>KEG13[Ⓐ]</p>	<div style="display: flex; align-items: center;">  <table border="1" style="margin-left: 20px;"> <thead> <tr> <th>model</th> <th>KEG15</th> <th>KEG13</th> </tr> </thead> <tbody> <tr> <td>A</td> <td>Ø25</td> <td>Ø30</td> </tr> </tbody> </table> <p>Ⓐ - Color : Yellow Red Orange Green Amber White</p> </div>	model	KEG15	KEG13	A	Ø25	Ø30
model	KEG15	KEG13								
A	Ø25	Ø30								

Dimension

Pilot Light

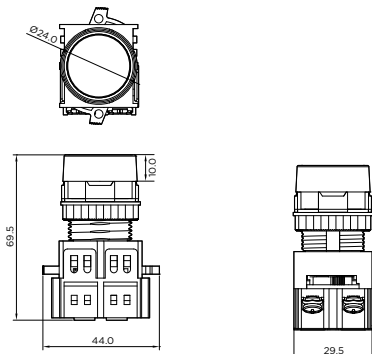

Non-Illuminated Push Button Switch

Momentary

Maintained

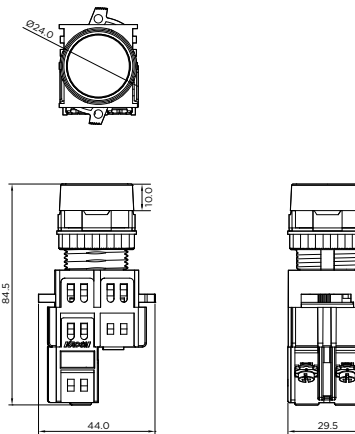
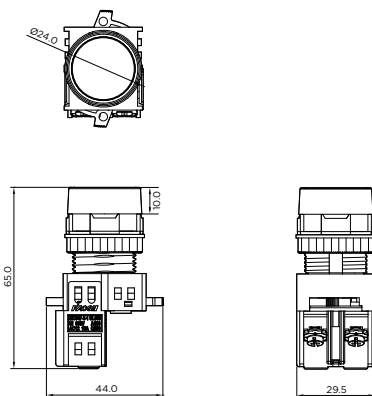

Illuminated Push Button Switch

Momentary

Maintained

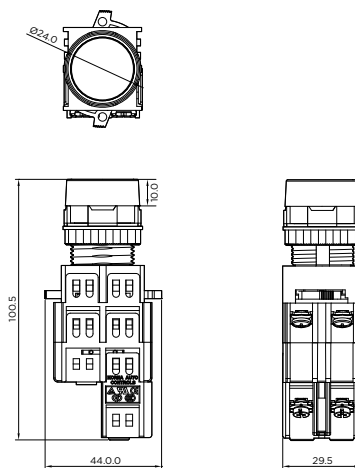
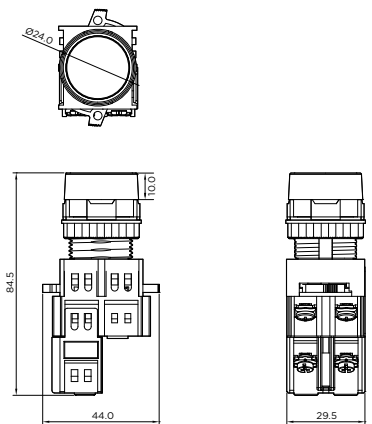

Human-Machine Interface

Control Switch

K25F AL series - Non-flush type

Dimension

Non-Illuminated Selector Switch

Knob Type

Lever Type

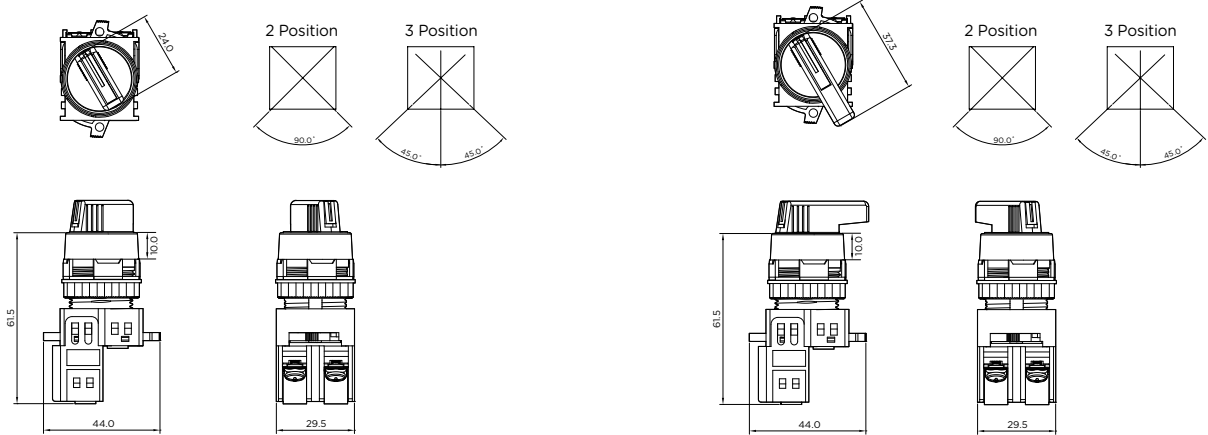

Illuminated Selector Switch

Knob Type

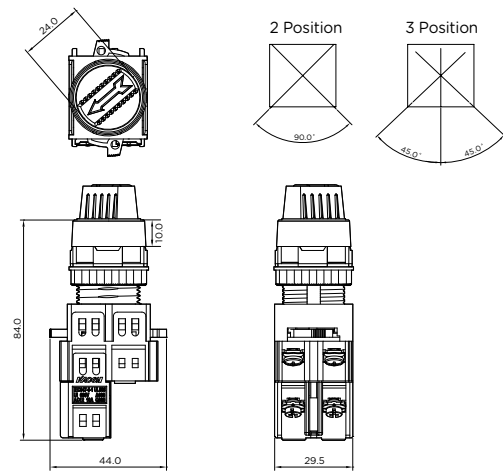

Dimension

Non-Illuminated Mushroom Push Button Switch

Ø29

Ø40

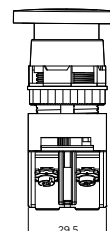
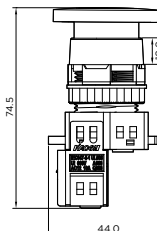
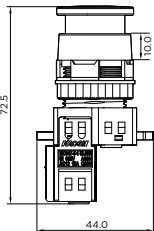
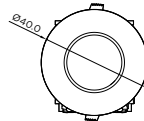
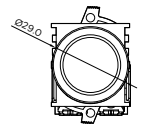

Illuminated Mushroom Push Button Switch

Ø29

Ø40

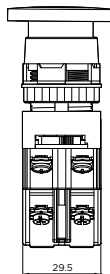
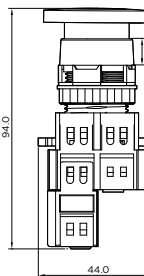
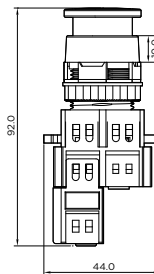
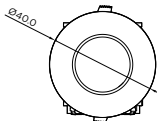
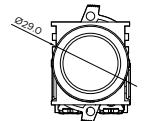

Human-Machine Interface

Control Switch

K25F AL series - Non-flush type

Dimension

Illuminated Buzzer

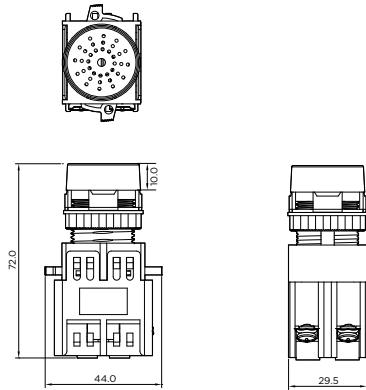

Panel cut out & Mounting hole panel mounting space

Panel Thickness : 0.5-4mm

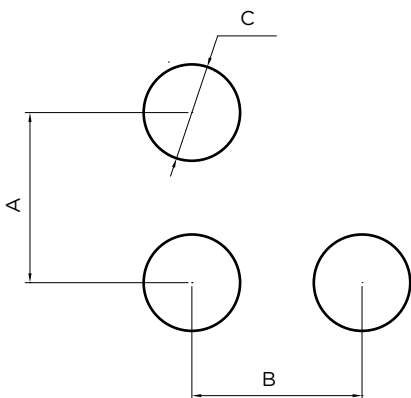

A	B	C
45	45	25.5

Contact block diagram

Diagram



Contract block configuration

	1NO	1NC	2NO	2NC	1NO+1NC	2NO+2NC
Non-Illuminated						
Illuminated						

※ This is example of contact block configuration for reference of usage. End user must config contact block according to their system.